



RIFAST® – Integrated functional elements with automated installation technology

ONE SYSTEM ENDLESS POSSIBILITIES



rifast



Fastening solutions tried and tested millions of times

RIFAST® – INTEGRATED FUNCTIONAL ELEMENTS

Our RIFAST® System is proven to help keep you ahead of the curve with the growing demands on car body production by optimizing functionality while simultaneously lowering both part weight and manufacturing costs. Our System has been proven millions of times to be affordable, flexible, and easy to use.

RIFAST® provides integrated functional elements for sheet metal components. RIFAST® elements are clinched in place. Through the utilization of our in-die or offline automated installation technology, we provide cost-effective assemblies when compared with welded joints. Our Rifast System provides joints that yield superior resistance to torsional and pushout forces – all advantages our customers can use to reduce cost and improve quality in their stamping





› RIFAST® Functional elements



› RIFAST® Automated installation technology



◀ Our RIFAST® System

From functional elements to automation technology – all from a single source.

plants and automated assembly lines in North America, Asia and Europe. This is because our customers benefit from a broad range of high-quality functional elements and automated installation technology – with reliable, guaranteed product features that span the entire service life.

RIBE® – WE ARE YOUR PARTNER FOR SOLUTIONS

As a systems specialist with more than 100 years of experience in manufacturing cold-formed parts and long-term plant engineering expertise, our goal is to provide secure fastening joints with a precision fit.

This is why we not only supply a comprehensive range of sheet metal joining components and automation devices, but also deliver unparalleled expertise. We offer comprehensive support – from advice on planning and sampling customized systems to commissioning, including training and after-sales service. All of the connecting solutions you need from a single source. Customized. By RIFAST®

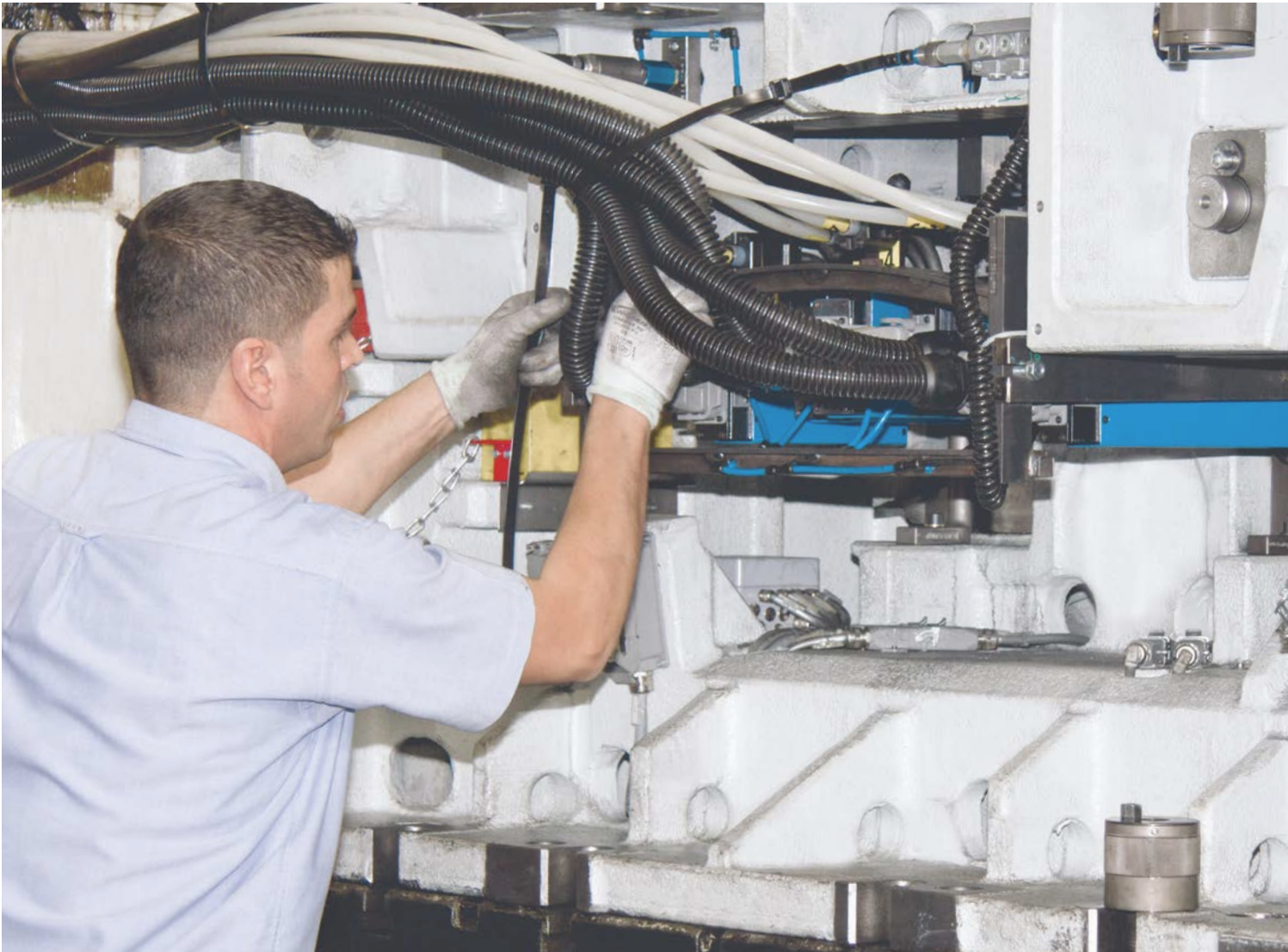

RIFAST® Technology

SOLUTIONS FROM A SINGLE SOURCE

When using RIFAST®, you rely on the benefits of a safe, comprehensive system that provides you with a distinct cost advantage over your competitors. Right from the start, our application engineers offer you excellent advice, our manufacturing facilities deliver optimally engineered elements that perfectly fit your needs, and our technicians provide you with professional maintenance and support. RIFAST® ensures you are optimally prepared – both now and in the future. Our research and development department is already engineering the safest, most secure fasteners for the future. RIFAST® systems that reliably meet tomorrow's requirements.



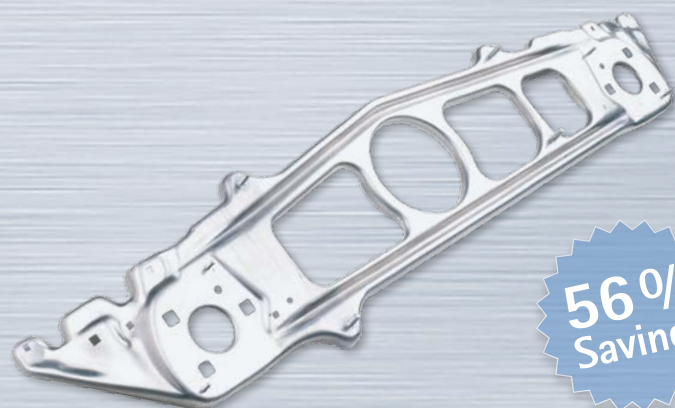

56%
Savings

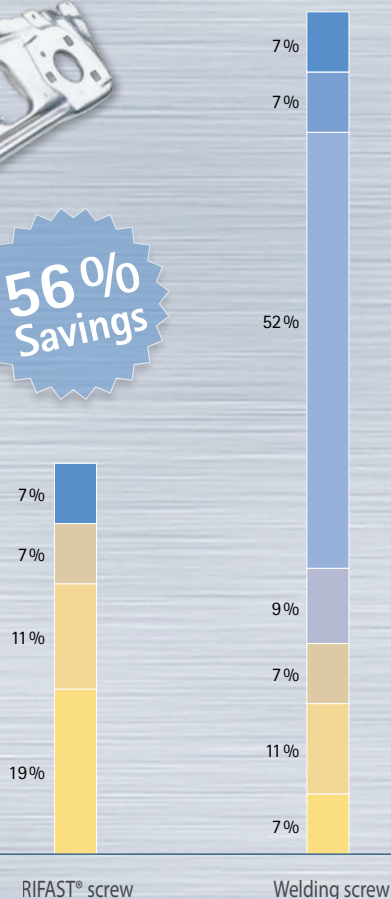
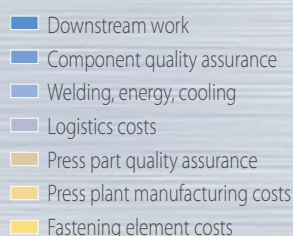

◀ RIFAST® Cost comparison

RIFAST® offers considerable cost benefits over welding screws.

YOUR TECHNICAL ADVANTAGES:

- Expert manufacturing and engineering advice provided by specialists in the field
- Application engineering and performance testing to determine key metrics for customer components utilizing RIFAST® elements
- Supply of functional elements
- Provision of automated process technology for feeding and clinching functional elements
- Fasteners with high positioning accuracy and strength

YOUR ECONOMIC ADVANTAGES:

- You save logistics costs because you only need to procure and store one fastening element – regardless of the sheet metal thickness.
- Lower labor and wage costs as there are fewer manufacturing stages in production.
- Reduce in-house WIP between manufacturing processes.
- Lower quality management costs as our RIFAST® system utilizes fully automated manufacturing which delivers process-reliable joints that meet the highest quality standards.



RIFAST® Application engineering

YOUR REQUIREMENTS – CUSTOM SOLUTIONS

Our application engineering offers you comprehensive support in developing perfect solutions. We consider your requirements and accompany you throughout the entire product development process. This is how RIFAST® application engineering enables you to develop components with RIFAST® functional elements at an early stage of the design process and test the parameters of the fastening to provide the highest quality joint.

In the development of every new application, our application engineers also determine the required installation force for your application. They specify the necessary RIFAST® tools, elements and sheet metal preparation to ensure a perfectly clinched joint for each new application.



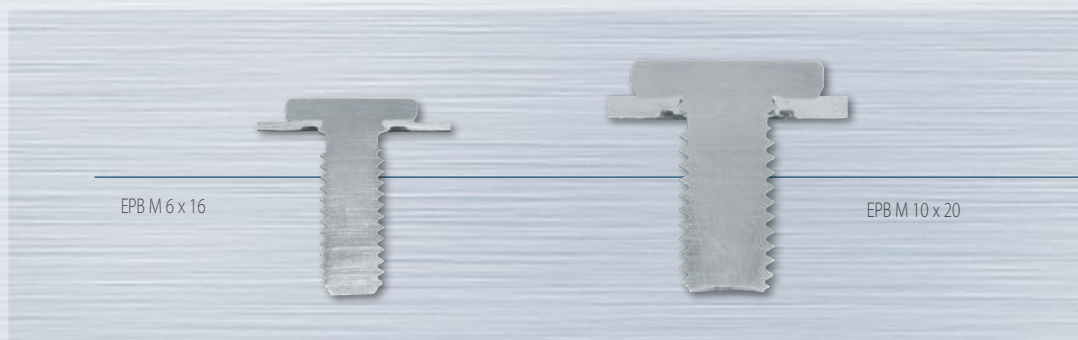

◀ Cross sections
EPB

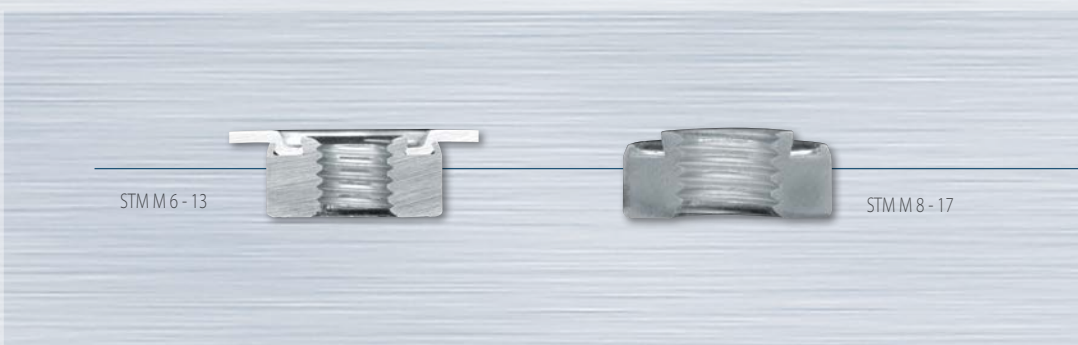

◀ Cross sections
STM

RIFAST® STANDARD TESTS:

For nearly every new application, our RIFAST® application engineering team will carry out a standard performance test of the new joint, which generally comprises of the following steps:

- Determination of application push-out force
- Determination of application breakloose torque
- Determination of applicable assembly torque
- Photo documentation
- Cross section/metallurgical mounts
- Compilation of a full test report

RIFAST® ADDITIONAL TESTING CAPABILITY:

The following testing options are available for individualized customer requests:

- Prototype tooling
- Assembly tests
- Water leak test
- Corrosion test

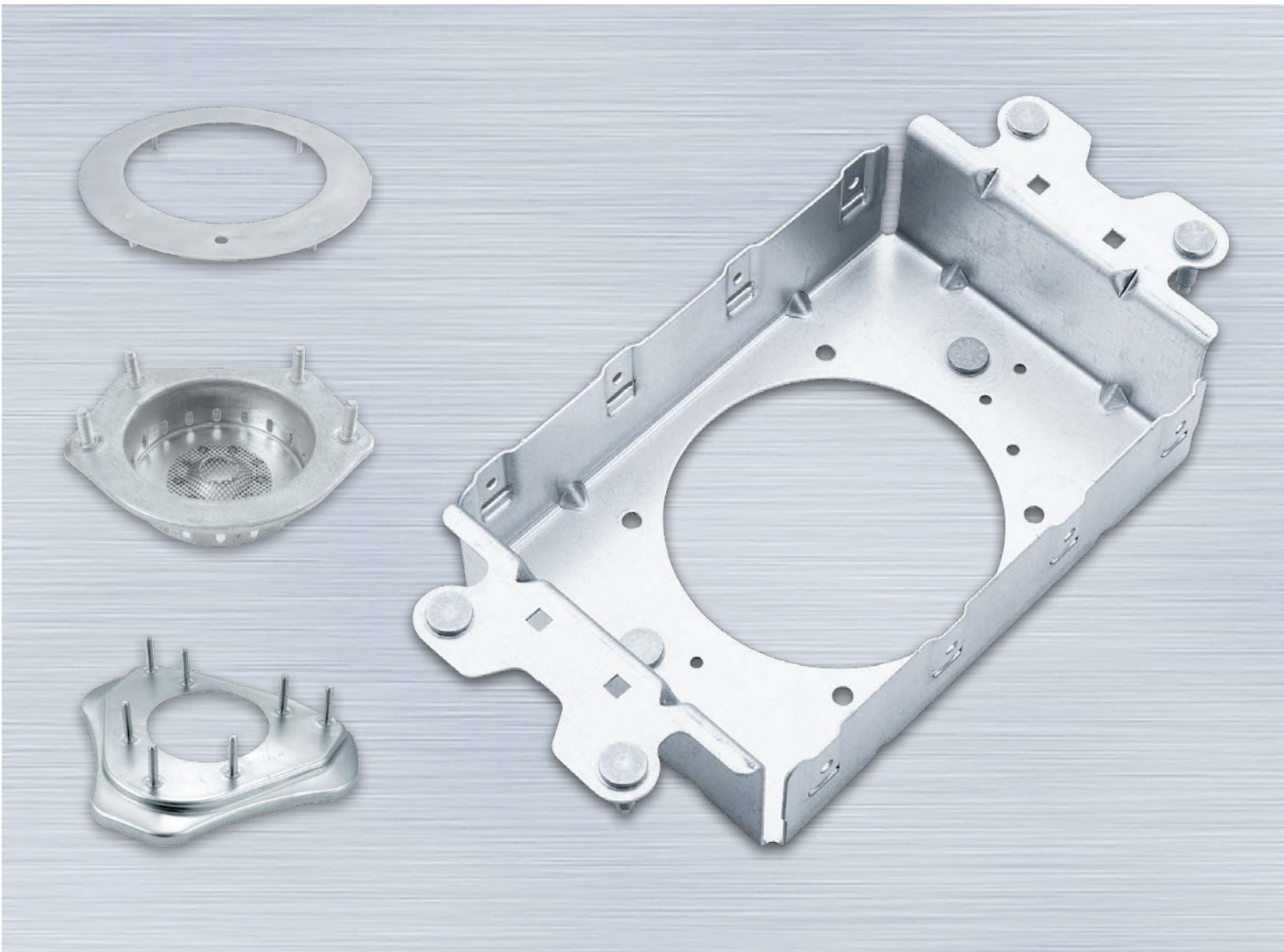

Advantages with diverse requirements

FUNCTIONAL ELEMENTS & INSTALLATION PROCESS

Do you have special sheet metal fastening manufacturing requirements? Then RIFAST® technology is the perfect choice for you. Our flexible system covers a wide range of products and applications. In addition to providing standard functional elements, we can also help you satisfy specific fastening requirements or engineer custom solutions with additional features or rivet applications.



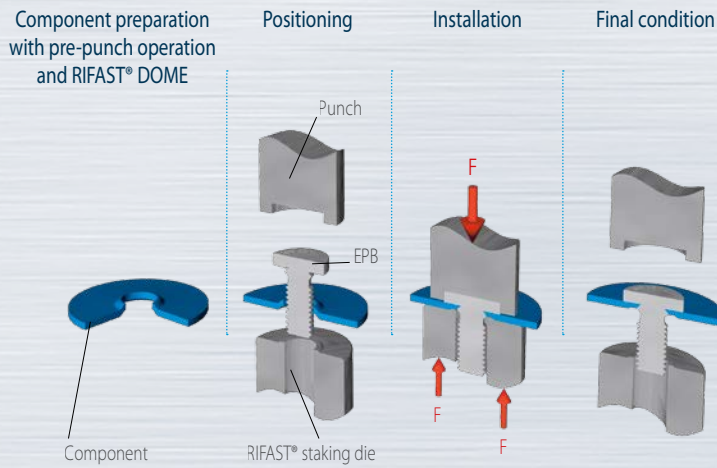

◀ EPB installation process
using a staking bolt

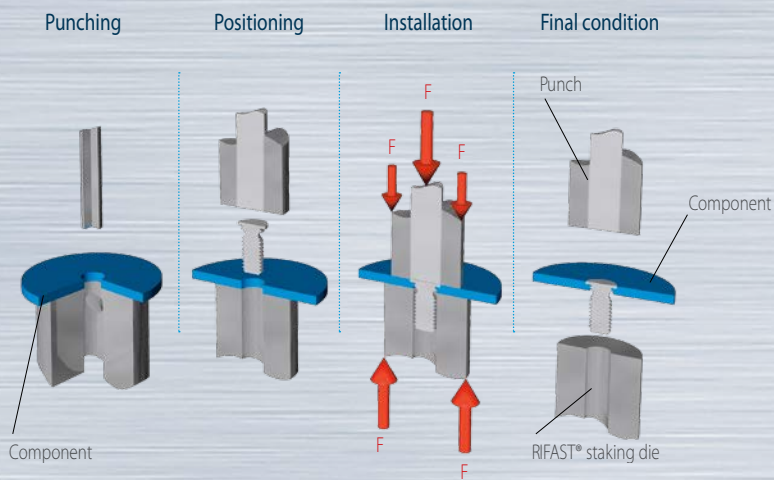

◀ SEB/DBB installation process
using a flush head staking bolt

RIFAST® INSTALLATION PROCESS

The RIFAST® clinching process is used to clinch our standard staking bolts (EPB), our flush head staking bolts (SEB), and our thick sheet metal staking bolts (DBB) in pre-punched steel or aluminum sheet metal components. The result: ready-to-use sheet metal components with an integrated functional element that meet all of your assembly and operation requirements.

- Staking bolts size M5 to M12
- Sheet metal thicknesses 0.75 mm to 9 mm
- RIFAST® staking bolts can be used with a variety of sheet metal materials including carbon steel, aluminum, and high-strength steels (HSLA)
- Corrosion-resistant in accordance with customer requirements
- Very high positioning accuracy
- Protection of surface coatings by installing into pre-punched sheet metals
- Very high resistance against torsional and push-out forces
- Water-tight joint
- Lowest in place joint cost

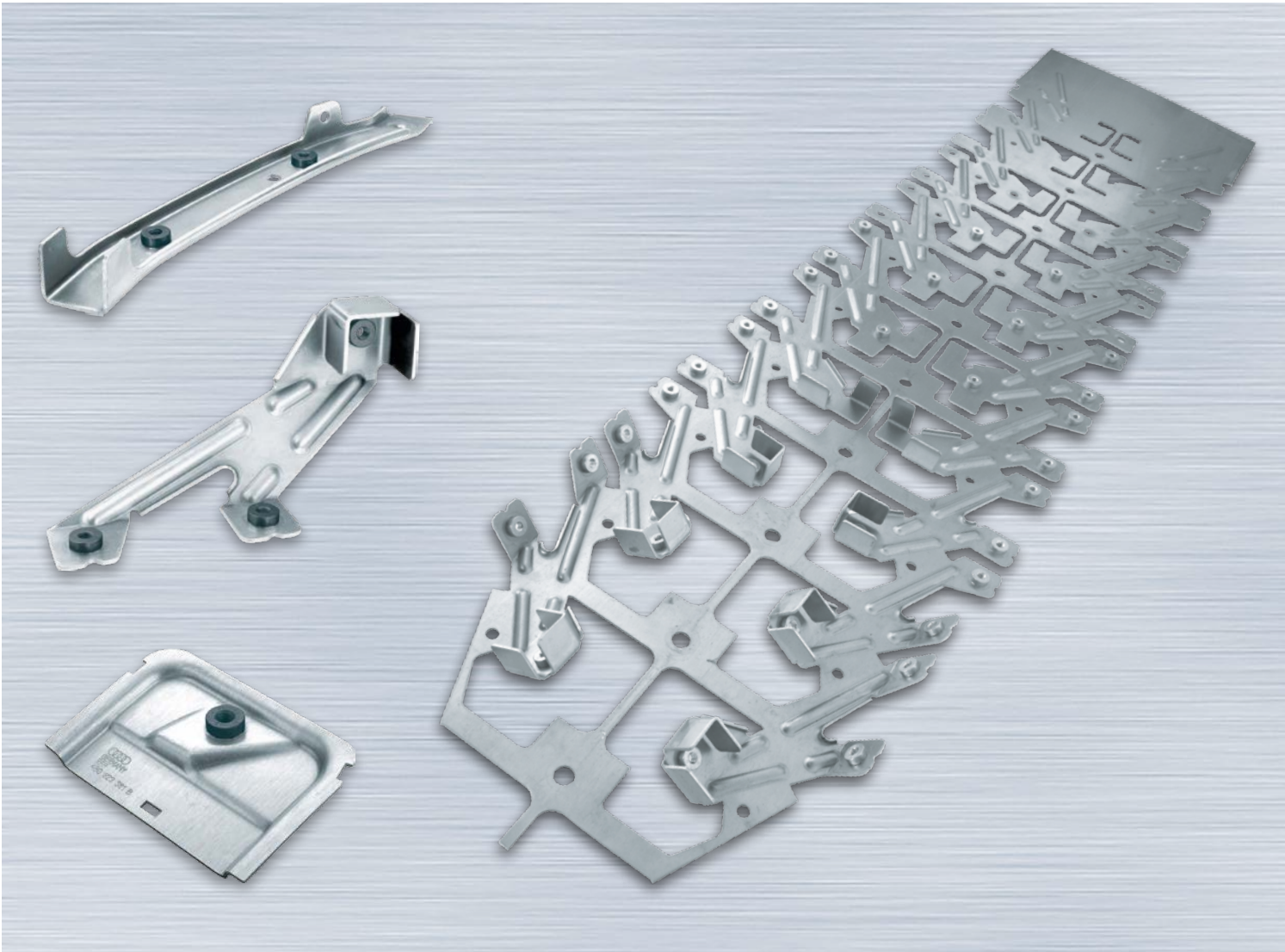

Advantages with diverse requirements

FUNCTIONAL ELEMENTS AND INSTALLATION PROCESS

RIFAST® SELF PIERCING PROCESS

With the RIFAST® punching process our self piercing nut (STM) is installed into an unperforated sheet metal in one stroke where it punches the hole required for the fastening and the sheet metal material flows to the undercut areas of the punch edge. This creates a fastened joint that provides superior resistance to push-out and torsional forces.

- Self Piercing Nuts: M5 to M10
- For sheet metal thicknesses of 0.6 to 2.0 mm
- Superior resistance against push-out and torsional forces
- Lowest possible component distortion in installation area
- Very high positioning accuracy
- Water-tight joint
- Highest cost-effectiveness thanks to reduction of tool stations

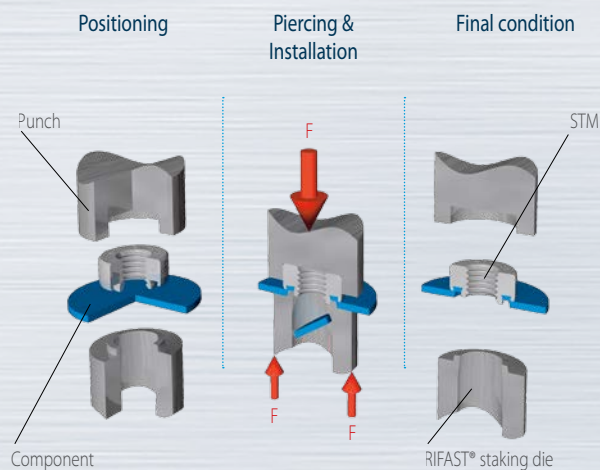

◀ STM installation process
using a self-piercing nut

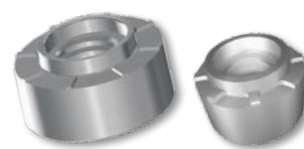
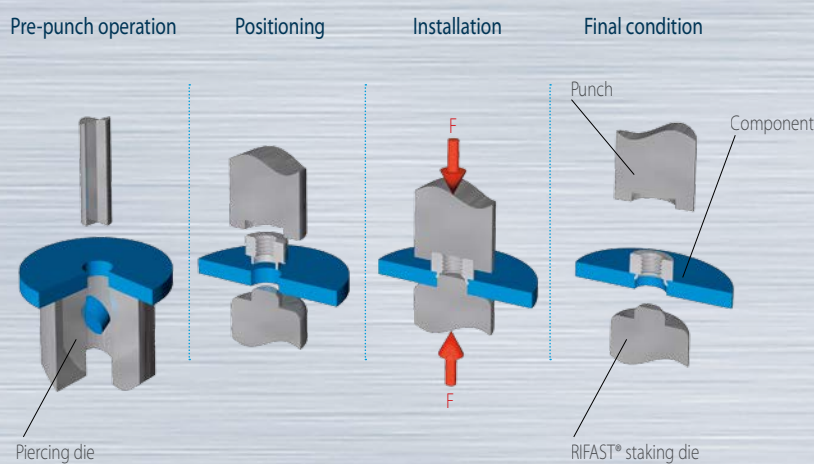

◀ DBM/LBM installation process
using a lightweight nut

RIFAST® RIVETING

RIFAST® riveting uses the lightweight nut (LBM) and the thick sheet metal nut (DBM) for pre-punched components. The component itself is only exposed to minor stresses because the pilot of the nut is expanded in the punched hole.

- **Lightweight nuts M5 to M8**
 - Sheet metal thicknesses 1.0 mm to 4.0 mm
 - Flat, non-distorted component surface after riveting
 - Specially developed for lightweight applications
 - Considerable weight savings
(LBM is ~ 70% lighter than our STM product line)
 - Better access due to more compact construction
 - Cost reduction through Lightweighting
- **Thick Sheet Metal Nuts: M5 to M12**
 - Sheet metal thicknesses > 2.0 mm
 - Flat, non-distorted component surface after riveting
 - Can also be used for component materials with low forming capacity
 - Superior resistance against push-out and torsional forces
 - Water-tight joint



RIFAST® automated installation technology

RIFAST® PROCESSING TECHNIQUE IN-DIE

The RIFAST® system also offers considerable savings potential by providing installation of the functional elements in-die. The RIFAST® system for stamping presses is composed of mobile feeder units (ZEM/ZES) and the punching head modules (VMM/VMS). Together with the RIFAST® functional elements we offer a global system with benefits that are proven.





◀ VMM/VMS
Punching head

◀ ZEM/ZES
Mobile feeder unit

RIFAST® FEEDER UNITS

RIFAST® feeder units can be designed with up to eight tracks and are readily adaptable to a variety of RIFAST® bolt and nut sizes. They excel thanks to their machine uptime, output (supporting high press speeds (strokes per minute)), and minimal set-up time. The feeder units have a touch-screen PLC independent of the stamping press. As an option, the control unit can be set up for remote diagnostics.

RIFAST® PUNCHING HEAD

RIFAST® punching heads are used for progressive or transfer tools. Due to their split compact design, the modules can be installed easily in a very space-saving manner in the upper and/or lower part of the stamping die. The operational sequence of the punching head is monitored electronically through the use of sensor inputs integrated with our RIFAST® feeder unit PLC program. This ensures process-reliable installation of the functional elements in complex components.

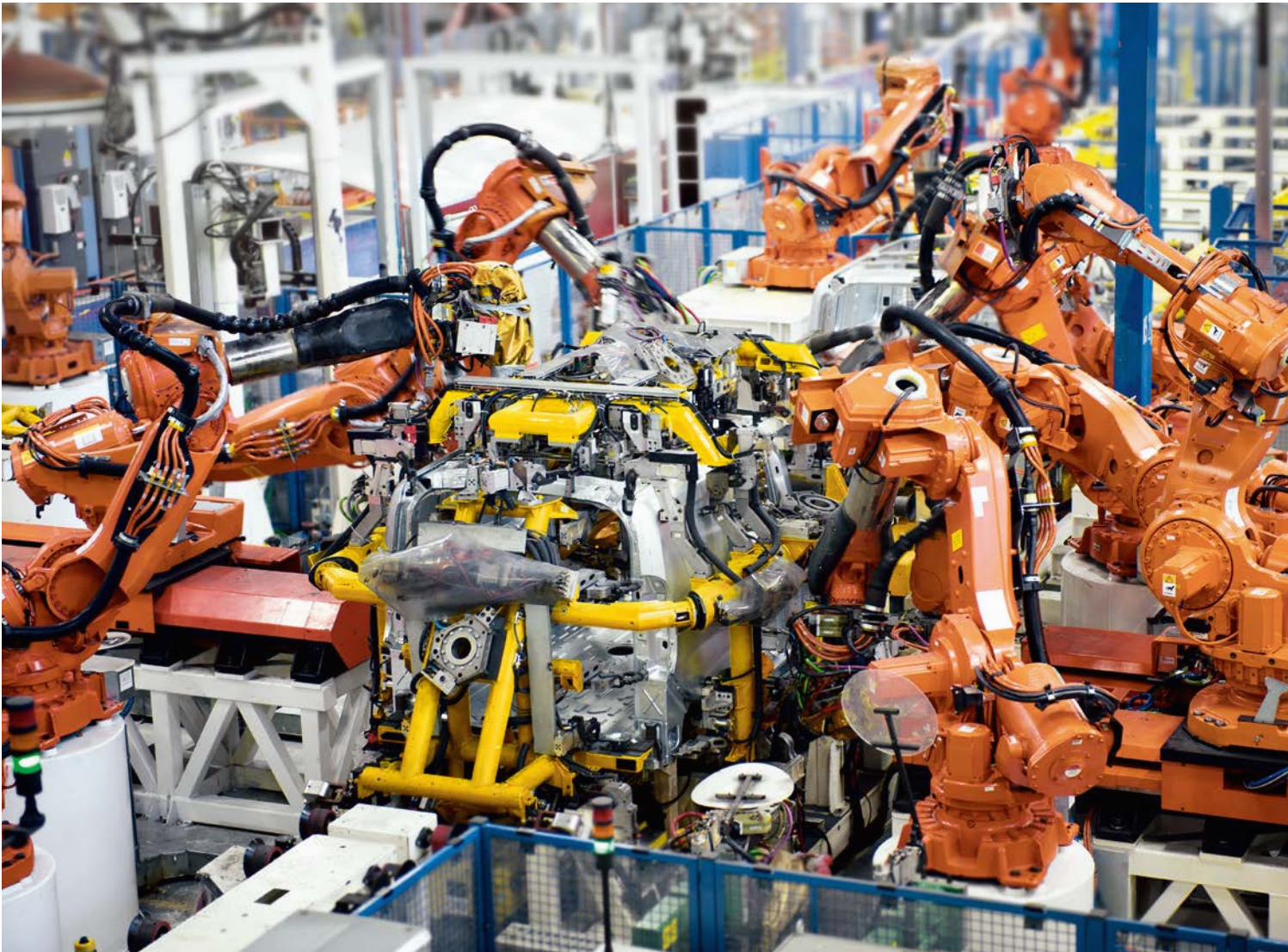

RIFAST® automated installation technology – C-frame

RIFAST® CAR BODY C-FRAME TECHNOLOGY

Cost-effective, quick and maximum positioning accuracy: If you require these characteristics to install functional elements in the car body, then the innovative RIFAST® C-frame technology is the right choice for you. For complex component structures that do not allow for in-die clinch fastener installation, we offer a solution designed for your requirements: RIFAST® C-frames.

How does it work? The RIFAST® C-frames allow you to place functional elements in the most complex components affordably and with very high positioning accuracy. During handling, the robot can present the component to the C-frame after which the functional element is installed.





Our C-frame is a modular system that ensures the perfect solution for a variety of applications. If you have a special requirement, our engineering team will develop a cost-effective solution. We have the expertise and the comprehensive practical experience based on many individual solutions for installing RIBEFAST® elements.

ENSURE PRECISION PERMANENTLY

As a systems provider, our goal is to ensure that our elements achieve high performance in components and that all of our systems run smoothly throughout their entire service life in any operating conditions. As an example, we intentionally uncoupled the drive unit from the setting unit and/or punching head on our C-frame. That way we can ensure the centering of the functional element, component hole, and RIBEFAST® staking die under challenging conditions over the entire operating life of the equipment.



RIFAST® automated installation technology – C-frame

RIFAST® – INSTALLATION TECHNOLOGY IN THE CAR BODY

RIFAST® – PROCESS-RELIABLE FEEDING

With our RIFAST® feeder unit for C-frames (CZM/CZB) up to four RIFAST® C-frames can be supplied independently with RIFAST® fastening elements in one cell.

- Supply of the C-frames for several hours without re-filling
- Flexible cell planning due to compact dimensions
- Carried out in one to four tracks thanks to our proven modular system
- Short set-up times to support a variety of RIFAST® fastening elements

Milled spiral feeder bowl designs ensure efficient output and easy replacement, if necessary. As an option, a PLC control unit can be integrated within the RIFAST® feeder allowing control of the feeder and the C-frame, if requested. This comprehensive RIFAST® system offers a tremendous cost advantage as four RIFAST® C-frames can be controlled from one RIFAST® feeder unit.





◀ Manual workplace
C-frame





◀ CZM/CZB
Feeder unit

RIFAST® Manual workplace – C-frame

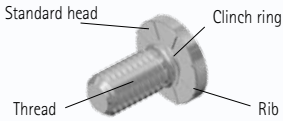
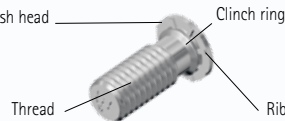
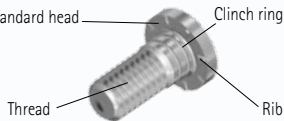
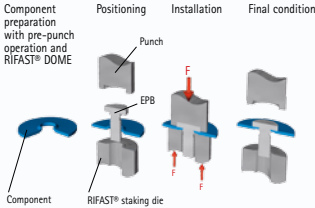
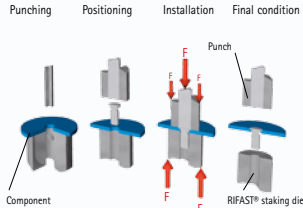
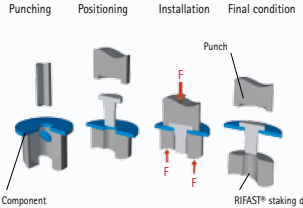

SOLUTION FOR SMALL SERIES PRODUCTION

The universal RIFAST® manual workstation for C-frames is our solution for cost-effective small series production. This flexible system is perfect for frequently changing components and functional elements or to implement prototype manufacturing design from one single system.

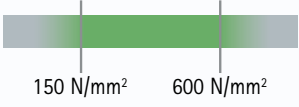
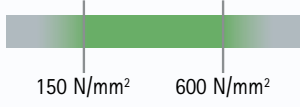
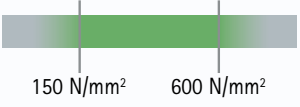
How does it work? Thanks to the use of easily exchangeable C-frame components and the ability to connect various component jigs and fixtures, the C-frame can be adapted to install functional elements into new components within a very short period of time. This flexibility makes the RIFAST® manual workstation for C-frames a cost-effective solution for a number of applications.

	EPB	SEB	DBB
Element			
Description	Bolt installed by clinching	Flush head staking bolt installed by clinching	Bolt installed by clinching
Joining process			
Component thickness (t)			
Component strength (R_m)			
Accessibility	on both sides	on both sides	on both sides
Installation technology	automated, partially automated and manual	automated, partially automated and manual	automated, partially automated and manual

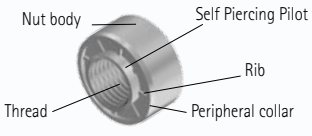
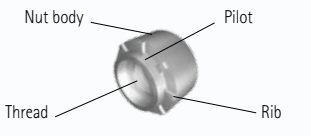
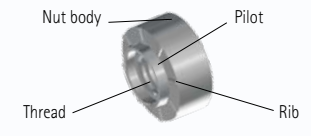
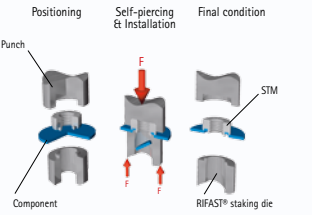
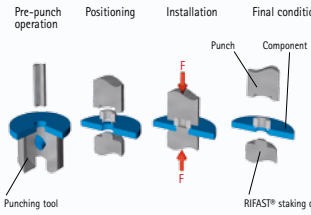
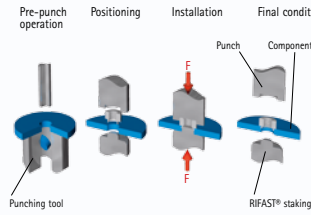
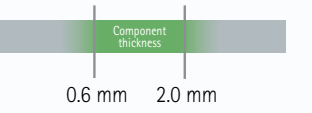
	ZEM + ZES	VMM + VMS	Fixed C-frame
Installation equipment	 during installation - fully automatic		 robot-guided - fully automatic

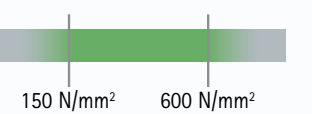
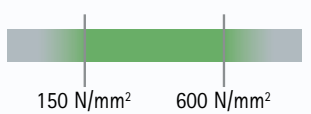
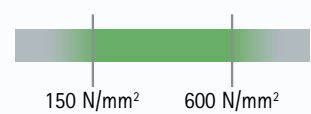
STM	LBM	DBM
		
Self-piercing nut installed by clinching	Nut installed by clinching	Nut installed by clinching
		
		
		
on both sides	on both sides	on both sides
automated, partially automated and manual	automated, partially automated and manual	automated, partially automated and manual

Different sheet metal thicknesses and component strengths can be checked for feasibility at our application laboratory upon request.

Manual workplace



◀ RIFAST® Functional elements and their installation process at a glance

◀ RIFAST® Automated installation equipment at a glance

WE CONNECT THE WORLD

RIFAST® USA

RIFAST Systems LLC.
3550 W Pratt Ave
Lincolnwood, IL 60712-3798
Phone: +1 847 / 933-8330
Fax: +1 847 / 677 8862
Email: nafta@rifast.com



RIFAST® China

RIBE® Joining Technologies (Shanghai) Ltd
Building 3, 1201 Xingqing Road
Jiading Shanghai 201815
Phone: +86 2169 / 169 058211
Fax: +86 2169 / 169055
Email: asia@rifast.com



RICHARD BERGNER VERBINDUNGSTECHNIK GMBH & CO. KG

RIFAST® Systemtechnik · Bahnhofstr. 8-16 · 91126 Schwabach · Germany
Phone: +49(0) 91 22/87-10 10 · Fax: +49(0) 91 22/87-15 37
Email: info@rifast.com · www.rifast.com